

Item	Qty.	Description
1	1	38" h curved panel
2	1	38" h curved panel
3	1	19" w x 38" h flat panel
4	1	38" h curved panel
5	1	38" h curved panel

Steps:

- 1) Assemble panels [1] through [5] together as shown. Refer to other page for LT Panel assembly instructions.
- 2) Place counter top onto assembled base.

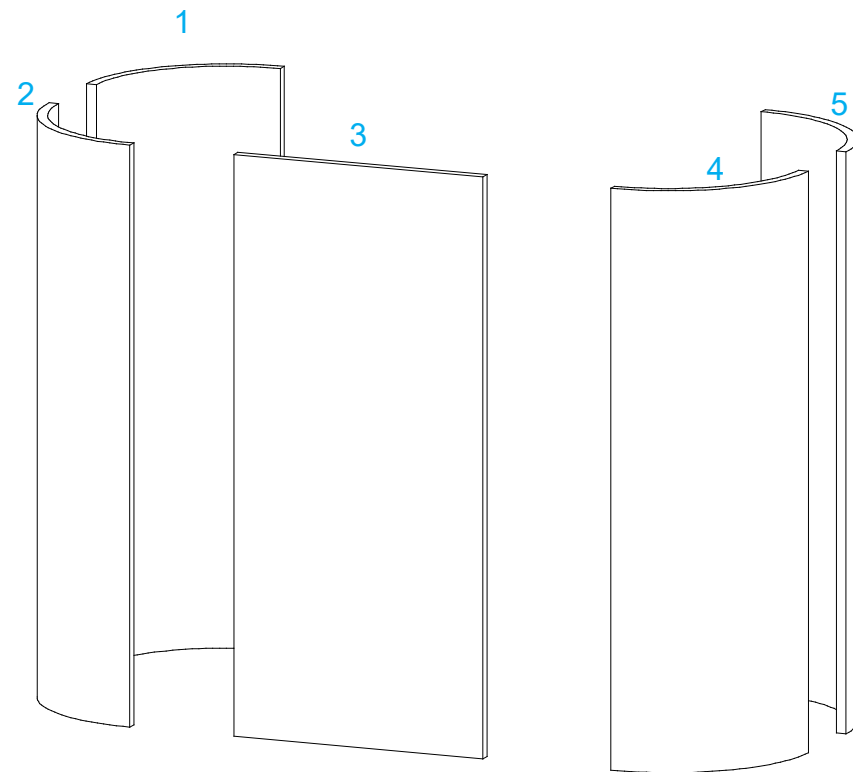

FRONT VIEW

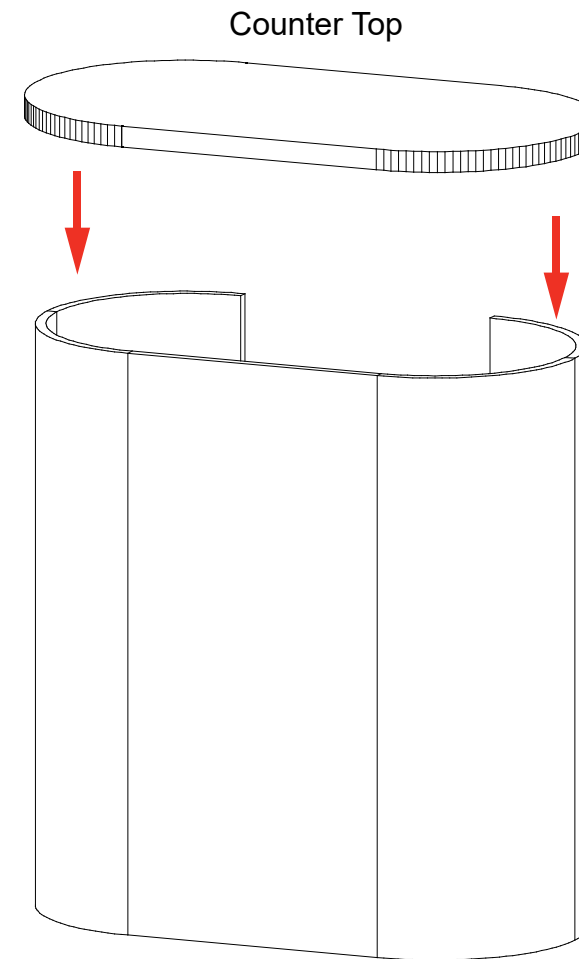

FRONT VIEW

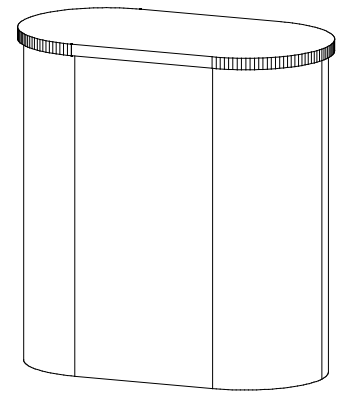

FRONT VIEW

When assembled

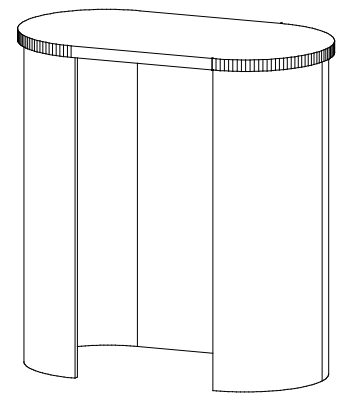

BACK VIEW

SETUP INSTRUCTIONS

euro It | HYBRIDS

Using Your Setup Instructions

The Euro LT Hybrids Setup Instructions are created specifically for your configuration. They are laid out sequentially in levels, including exploded views, and a logical series of detailed steps to assemble the main structure and components. We encourage you to study the instructions **before** attempting to assemble your exhibit.

Each page reminds you to tighten the setscrews after disassembling your exhibit to prevent loss of the locks and setscrews (see below in RED). This is VERY IMPORTANT.

Cleaning and Packing Your Display

- 1) Use care when cleaning aluminum extrusion or acrylic inserts. Use only non-abrasive cleaners.
- 2) When cleaning laminate inserts, countertops, or panels use mild cleansers and a soft material such as cotton.
- 3) Keep all display components away from extreme heat and long exposure to sunlight to avoid warping and fading.
- 4) Retain all packing material. It will make re-packing much easier and will reduce the likelihood of shipping damage.

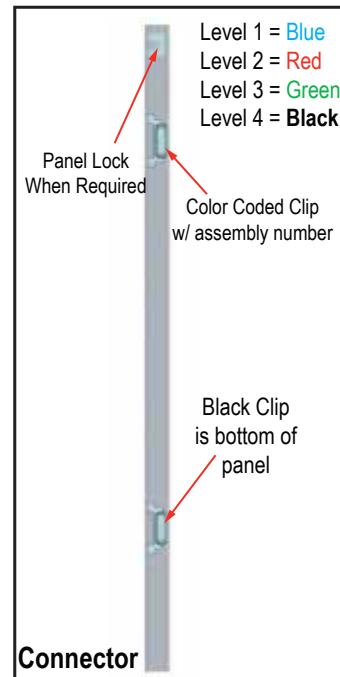

Each component has 2 clips, the lower clip is ALWAYS black. The top clip is color coded to distinguish which level. The color coded clip also contains the numbered label.

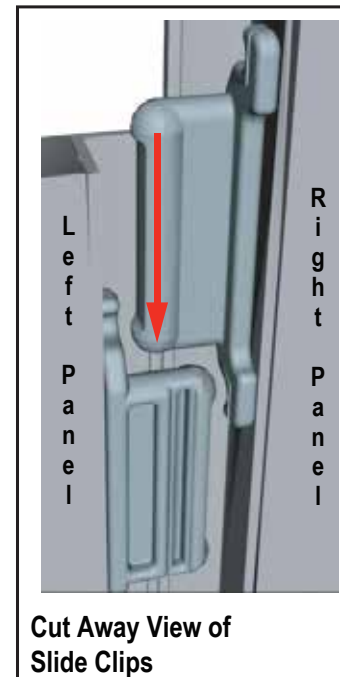

Components connect together by aligning them and sliding downward connecting clips together.

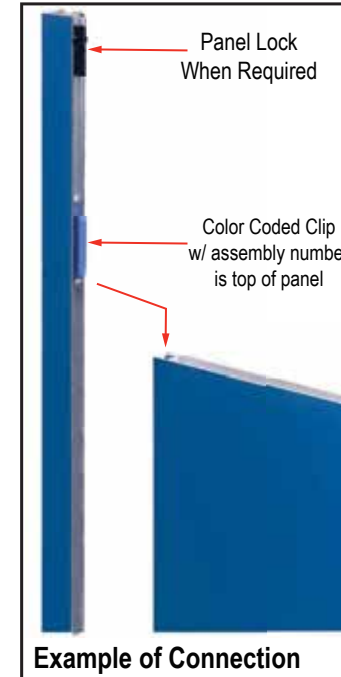

Configurations are assembled from left to right, usually starting with #1 and following the numbered sequence.

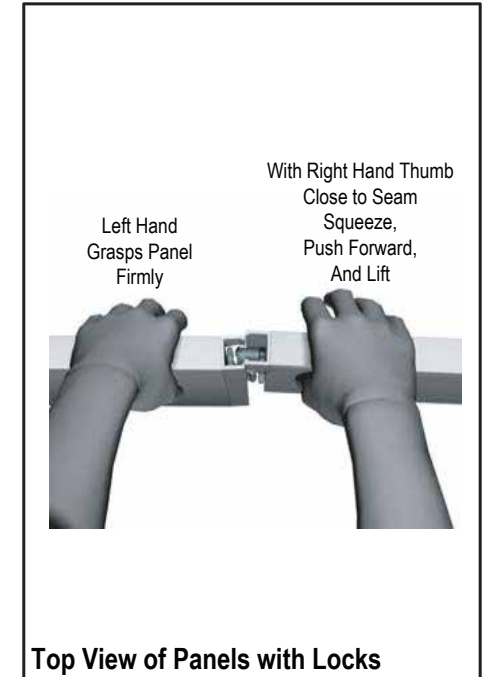

The first level of components contain panel locks that are located at the top of the panel for extra stability and seamless connection. When disassembling panels twist top connection slightly and lift right panel upward.

General Setup Instructions for Extrusion System



Most exhibits can be assembled with the supplied Hex Key Tool. Occasionally, a flat head screwdriver may be required.

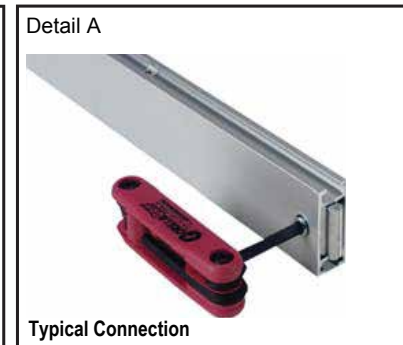

Most horizontal extrusion connections have a patented expandable lock. This lock inserts into the groove of an opposing extrusion. Tightening the lock with the Hex Key Tool expands the lock and creates a strong positive connection.



Each extrusion contains a numbered label which corresponds with setup instructions. The label is located within a groove of the extrusion (when possible). With extrusion components the labels contain Black numbers unless otherwise specified.

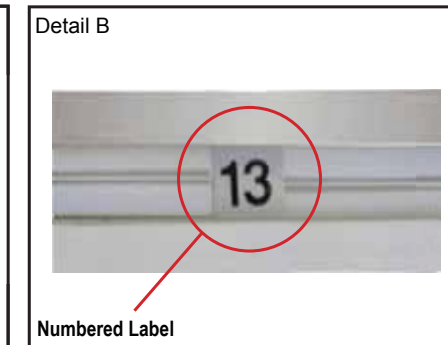

Remove only (1) setscrew when disassembling. Replace setscrew in extrusion after assembling it. Before packing, replace setscrew in extrusion to avoid losing it.

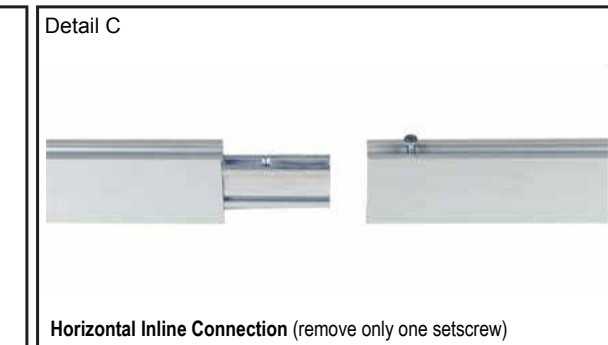

Attach base plate to round or square vertical extrusion using the bolt provided. Be careful not to strip the threads.

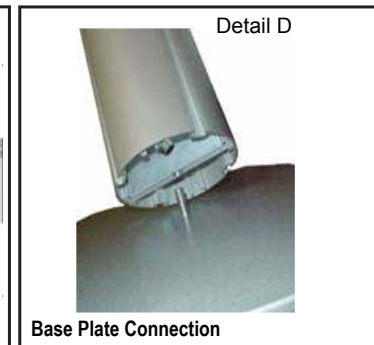

When vertical extrusions are packed in portable cases rather than crates or tubs, they must be broken down into smaller sections which then require assembly.

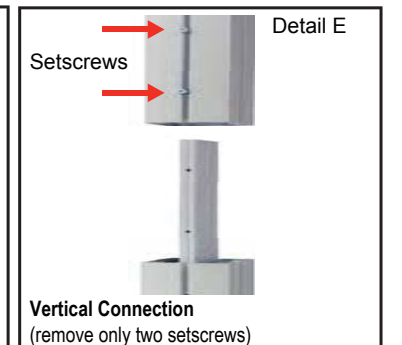

Remove only (2) setscrews when disassembling. Replace setscrews in extrusion after assembling it. Before packing, replace setscrews in extrusion to avoid losing them.

Top View of Each Level

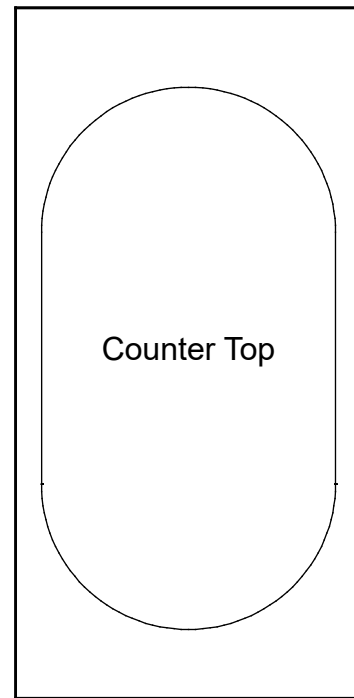

Level 1
(Bottom level)

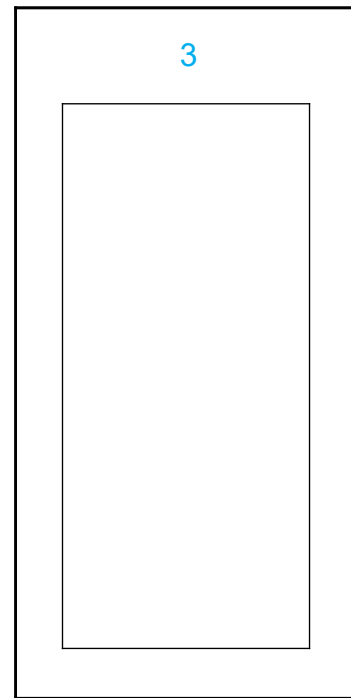

Level 2

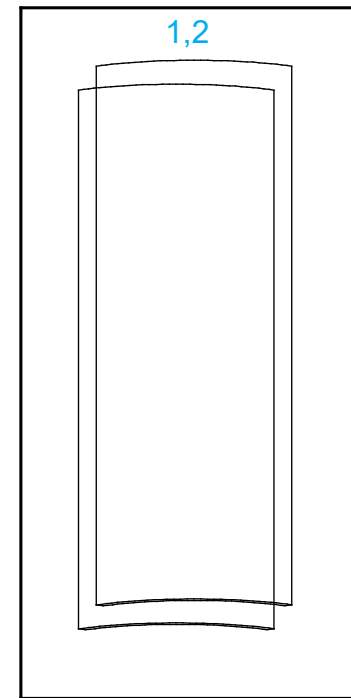

Level 3

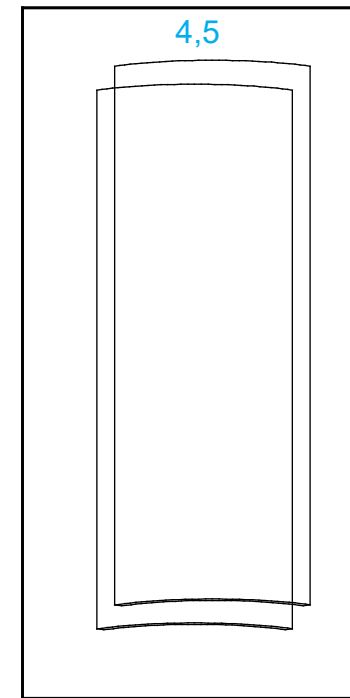

Level 4