

Perspective View

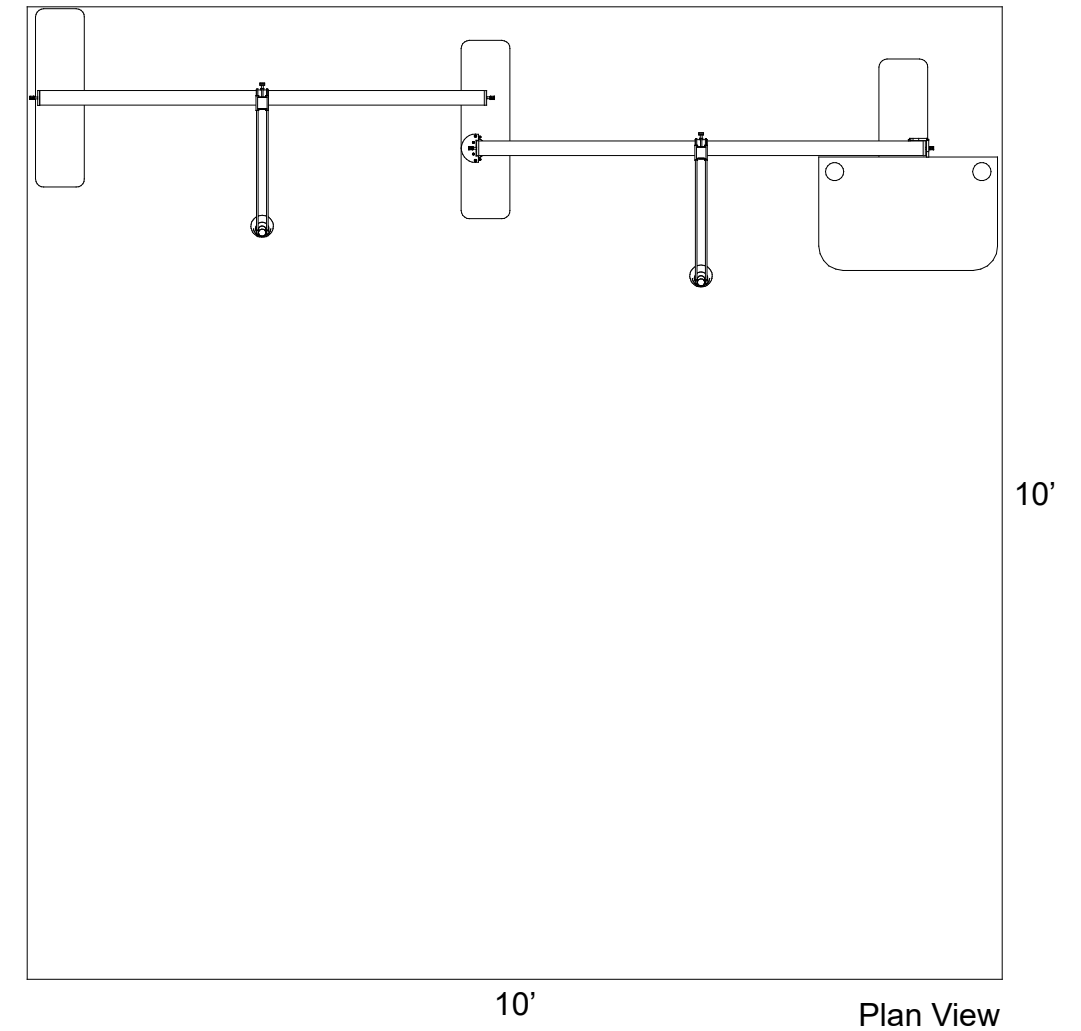

Plan View

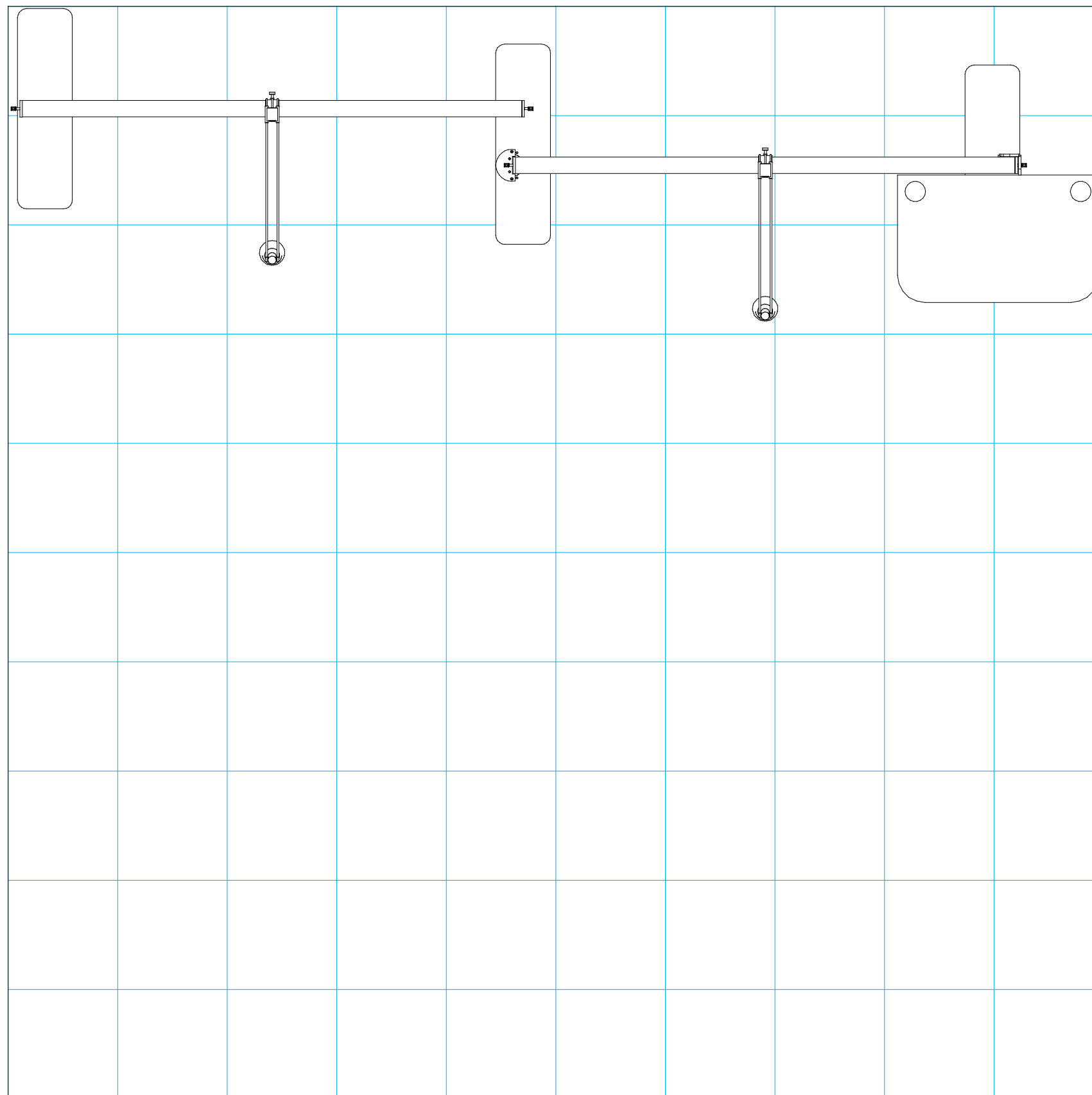

= 1 sq ft

General Setup Instructions

- Read entire setup instruction manual prior to unpacking parts and pieces.
- The setup instructions are created specifically for this configuration.
- Setup instructions are laid out sequentially in steps, including exploded views with detailed explanation for assembly.



Part Identification - Numbering

Cleaning & Packing

- For Cleaning Metal, Plex, & Laminate Parts: Use a **MILD NON-ABRASIVE** cleanser and soft cloth/paper towel to clean all surfaces.
- Keep exhibit components away from heat and prolonged sun exposure.
Heat and UV exposure will warp and fade components.
- Retain all provided Packing Materials. All provided packing materials are for ease of repacking & component protection.

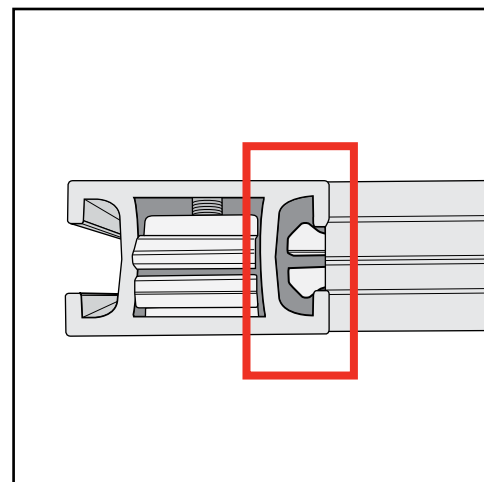

Engaged Lock



WARNING



DO NOT USE POWER TOOLS



ALL CONNECTIONS MUST BE TIGHTLY SECURED

Disassembly

- For loss prevention, keep all knobs & connectors attached to extrusions during disassembly.

Straight Connection

When assembling frame, first attach all **straight connectors**, then attach **corner connectors**.

- 1) Place extrusions end-to-end.
- 2) Loosen all knobs, then slide **straight connector** across the seam of extrusions.
- 3) Tighten all knobs to secure connection.



Slide connector across seam of extrusions.
Tighten all knobs.



Disassembly

- 1) Loosen all knobs.
- 2) Slide connectors off of one extrusion.
- 3) Tighten knobs to prevent loss during packing & shipping.

Keep straight connectors in groove of extrusion. Do not remove connectors during disassembly.

All knobs must be tightened securely to ensure a proper connection.

Corner Connection

- 1) Loosen knobs, then slide vertical extrusions onto **corner connectors** of **lower** horizontal extrusion.
- 2) Slide **corner connectors** of **upper** horizontal extrusion into grooves of vertical extrusions.
- 3) Tighten all knobs to secure connection.

Disassembly

- 1) Loosen knobs on vertical extrusions.
- 2) Slide the vertical extrusions off of **corner connectors** on lower and upper horizontal extrusions.



Slide verticals over lower connectors.

Then slide upper connectors into groove of verticals.

Tighten all knobs.



Adjust connectors if necessary to prevent gaps in connection.



COMPLETED ASSEMBLY

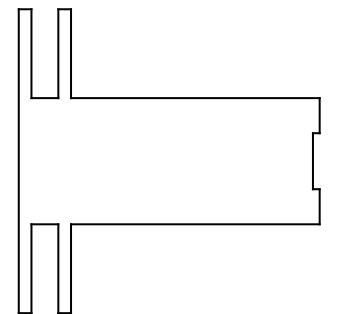

TSP49 Profile

All knobs must be tightened securely to ensure a proper connection.

Top View of Each Level

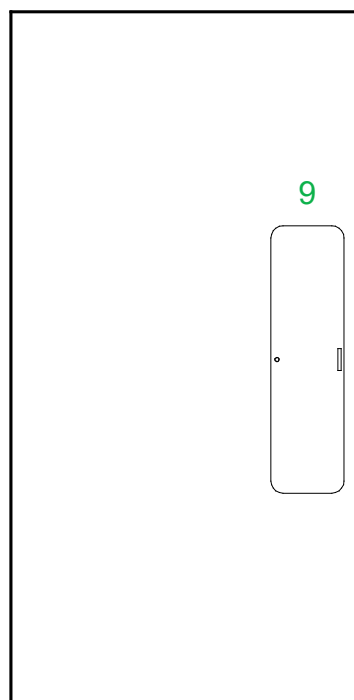

Level 1
(Bottom level)

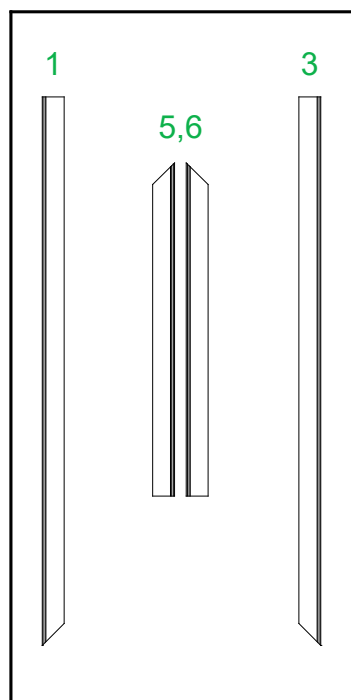

Level 2

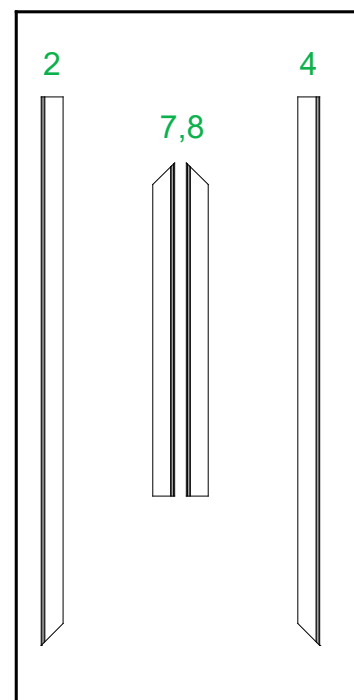

Level 3

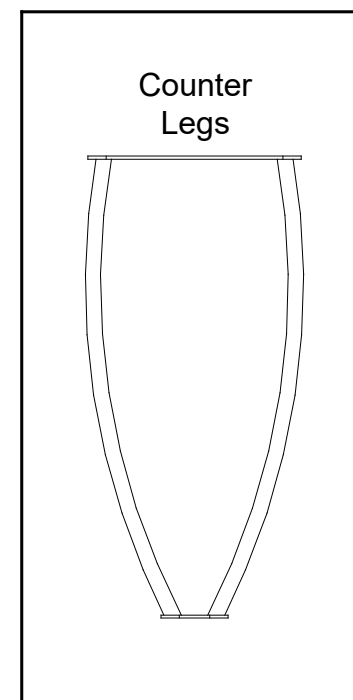

Level 4

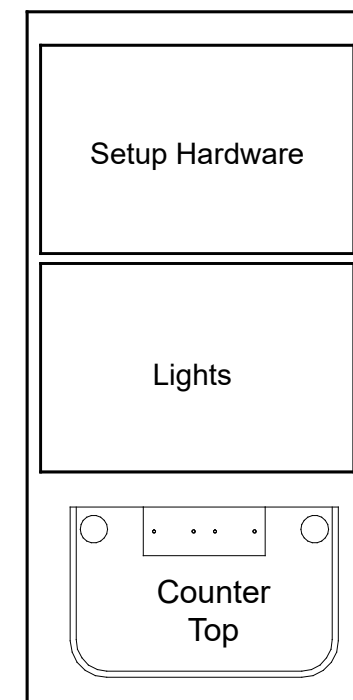

Level 5

Top View of Each Level

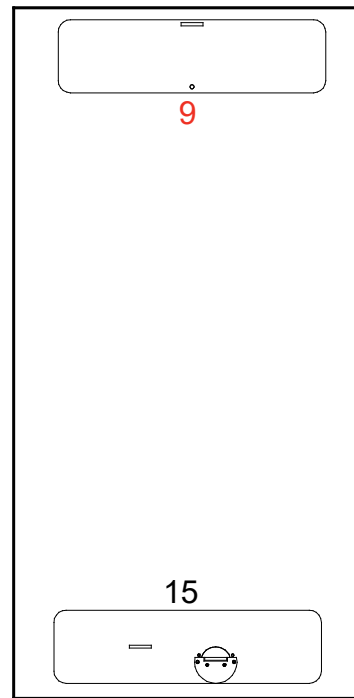

Level 1
(Bottom level)

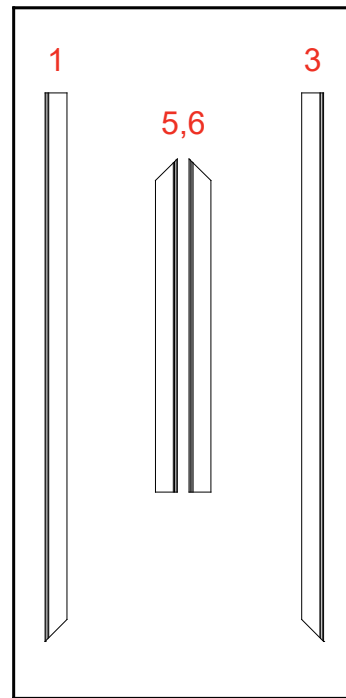

Level 2

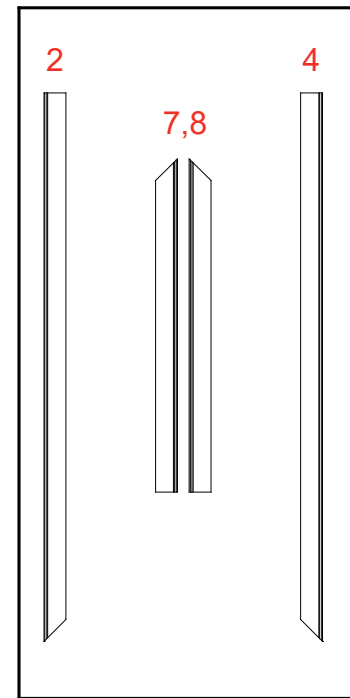

Level 3

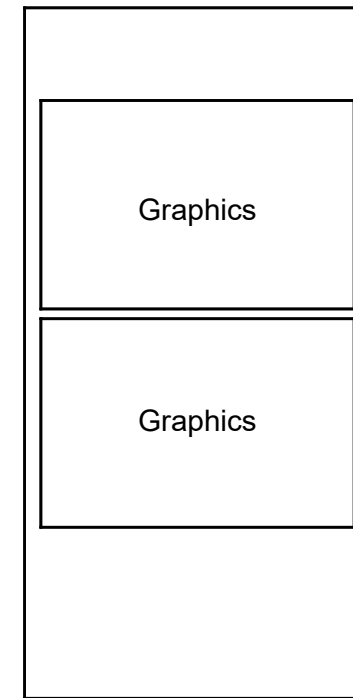

Level 4

Item	Qty.	Description
1	1	45"h TSP49 Vertical Extrusion
2	1	45"h TSP49 Vertical Extrusion
3	1	45"h TSP49 Vertical Extrusion
4	1	45"h TSP49 Vertical Extrusion
5	1	27.35"w TSP49 Horizontal Extrusion
6	1	27.35"w TSP49 Horizontal Extrusion
7	1	27.35"w TSP49 Horizontal Extrusion
8	1	27.35"w TSP49 Horizontal Extrusion
9	1	6" x 22" End Base Plate w/ foot

Steps:

Refer to the *Tool-less Frame Assembly* general information page.

- 1) Assemble vertical extrusions [1-2], [3-4] & horizontal extrusions [5-6], [7-8] together, using **Tool-less Spline connectors** labeled [X].
- 2) Connect vertical assemblies [1/2], [3/4] between horizontal assemblies [5/6], [7/8], using **Tool-less Corner Connectors** labeled [A].
- 3) Install Base Plate [9] to bottom corners of frame assembly as shown. See **Base Plate Attachment** detail.

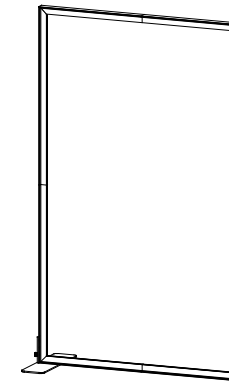

When assembled

Assemble frame flat on ground.

*** Tool-less Spline Connector**

1. Place extrusions end-to-end.

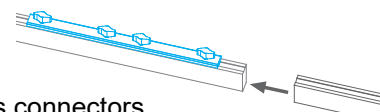

2. Slide tool-less connectors across seam of extrusions.

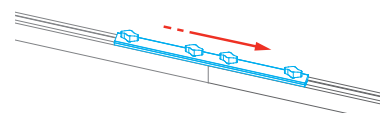

3. Tighten all knobs to secure connection.

*** Tool-less Corner Connector**

1. Slide extrusion onto Corner Connector.
2. Tighten all knobs to secure connection.

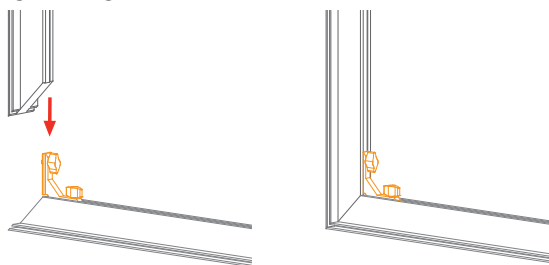

Keep corner connectors attached to horizontal extrusions.

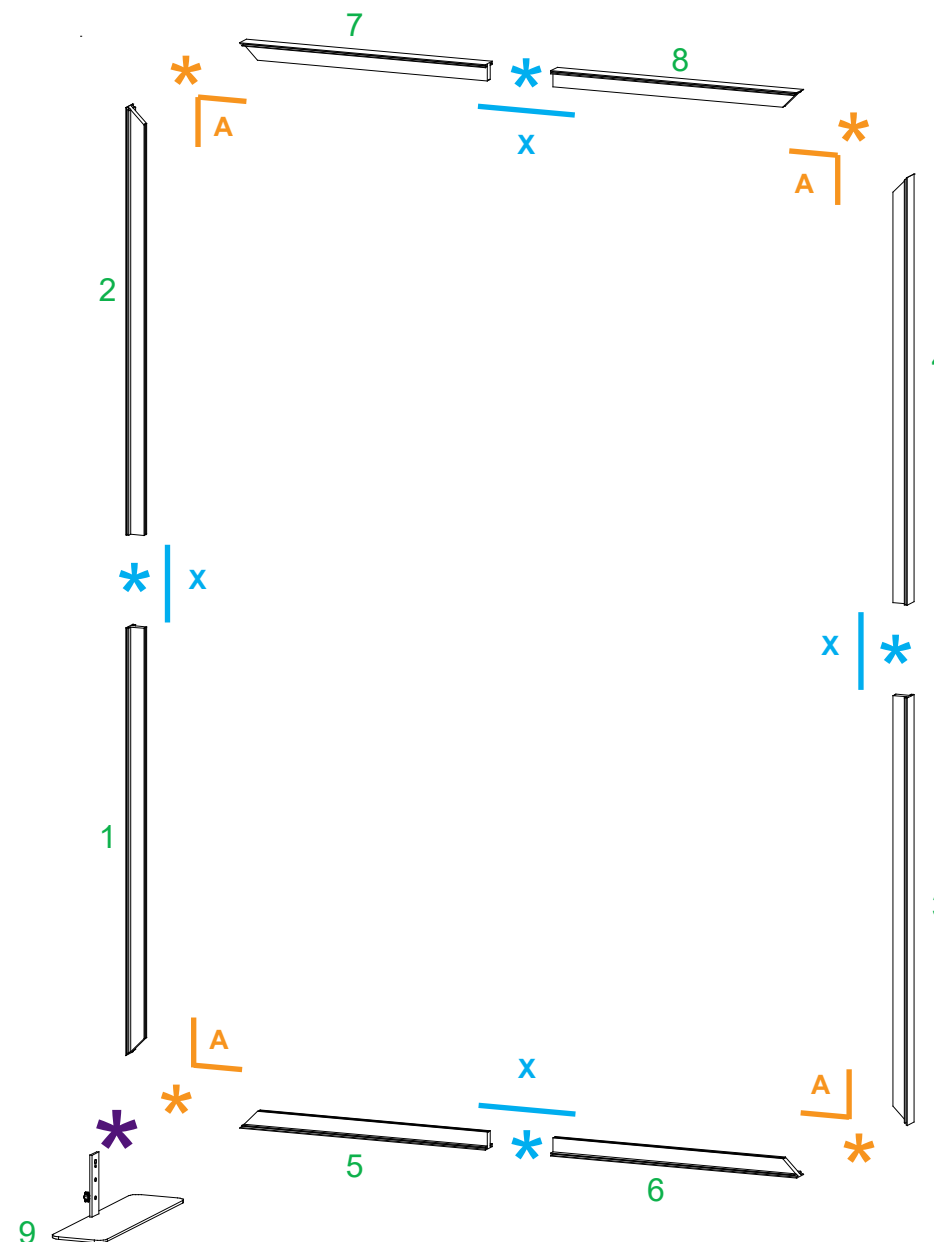

*** Base Plate Attachment**

- 1) Place key hole over bolt on panel & slide down.
- 2) Twist knob to secure connection.

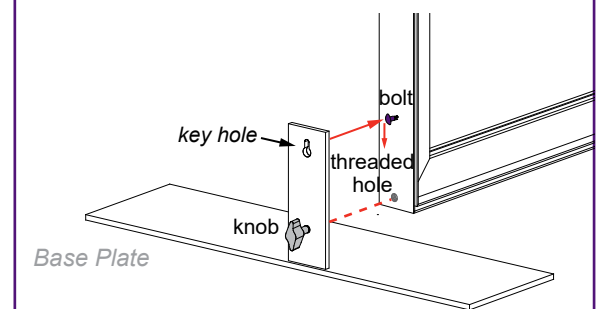

Item	Qty.	Description
1	1	45"h TSP49 Vertical Extrusion
2	1	45"h TSP49 Vertical Extrusion
3	1	45"h TSP49 Vertical Extrusion
4	1	45"h TSP49 Vertical Extrusion
5	1	27.35"w TSP49 Horizontal Extrusion
6	1	27.35"w TSP49 Horizontal Extrusion
7	1	27.35"w TSP49 Horizontal Extrusion
8	1	27.35"w TSP49 Horizontal Extrusion
9	1	6" x 22" End Base Plate w/ foot

Steps:

Refer to the [Tool-less Frame Assembly](#) general information page.

- 1) Assemble vertical extrusions [1-2], [3-4] & horizontal extrusions [5-6], [7-8] together, using [Tool-less Spline connectors](#) labeled [X].
- 2) Connect vertical assemblies [1/2], [3/4] between horizontal assemblies [5/6], [7/8], using [Tool-less Corner Connectors](#) labeled [A].
- 3) Install Base Plate [9] to bottom corners of frame assembly as shown. See [Base Plate Attachment](#) detail.

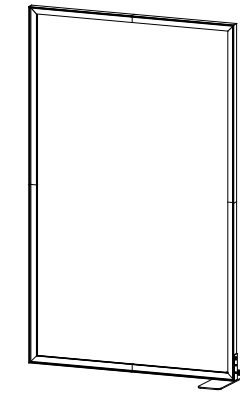

When assembled

Assemble frame flat on ground.

*** Tool-less Spline Connector**

1. Place extrusions end-to-end.

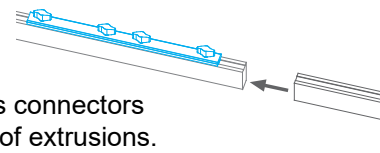

2. Slide tool-less connectors across seam of extrusions.

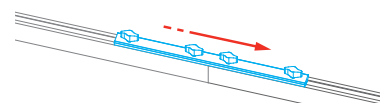

3. Tighten all knobs to secure connection.

*** Tool-less Corner Connector**

1. Slide extrusion onto Corner Connector.
2. Tighten all knobs to secure connection.

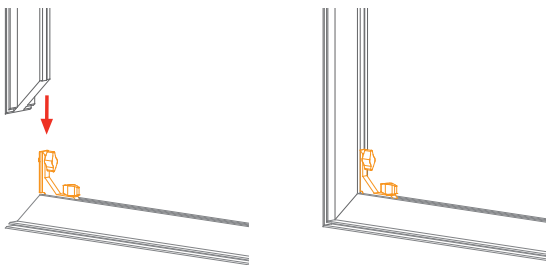

Keep corner connectors attached to horizontal extrusions.

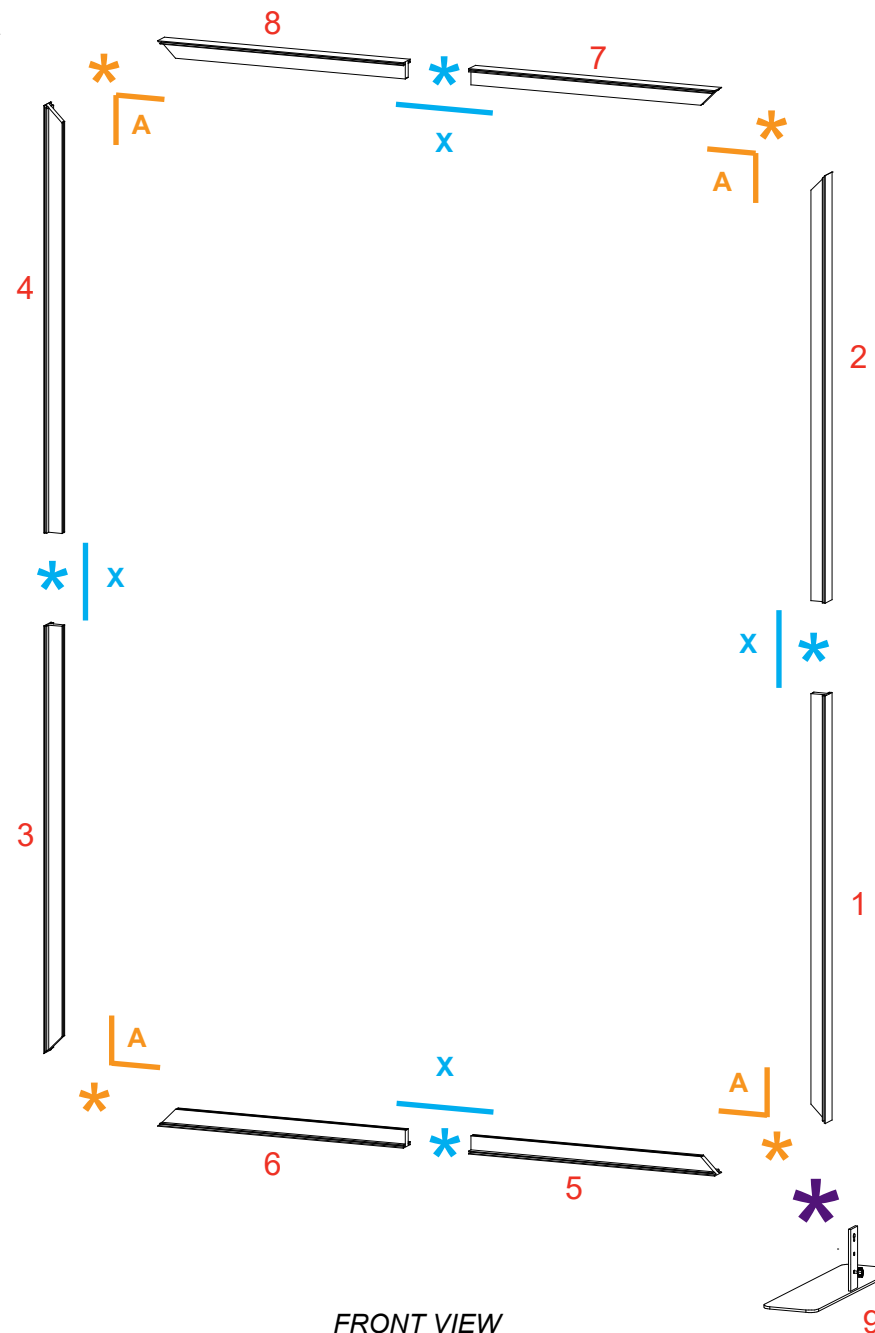

*** Base Plate Attachment**

- 1) Place key hole over bolt on panel & slide down.
- 2) Twist knob to secure connection.

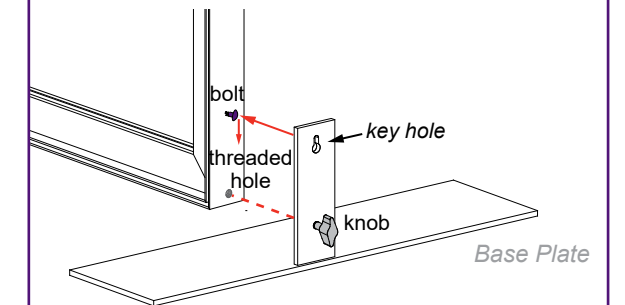

Item	Qty.	Description
15	1	6" x 22" Two-Connection Base Plate

- Steps:
- 1) Install Base Plate [15] to vertical [3/4] of right frame.
See [Right Frame Base Plate Attachment](#) detail.
 - 2) Connect vertical [3/4] of left frame to Base Plate [15].
See [Left Frame Base Plate Attachment](#) detail.

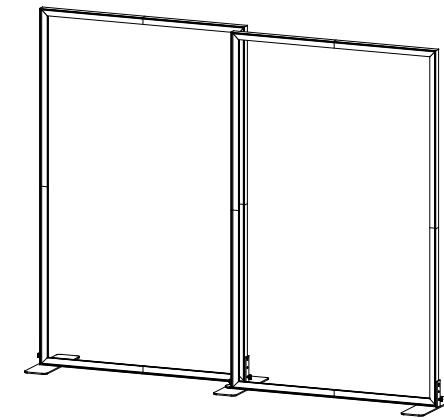

When assembled

*** Right Frame Base Plate Attachment**

- 1) Place key hole over bolt on panel & slide down.
- 2) Twist knob to secure connection.

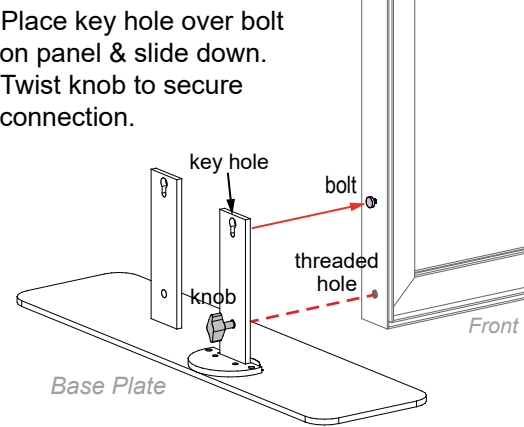

*** Left Frame Base Plate Attachment**

- Place key hole over bolt on panel & slide down.
Twist knob to secure connection.

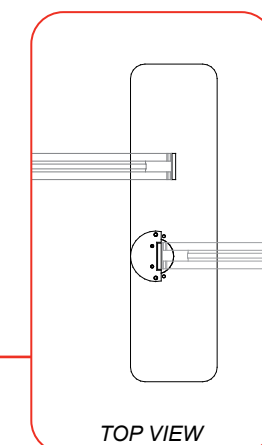
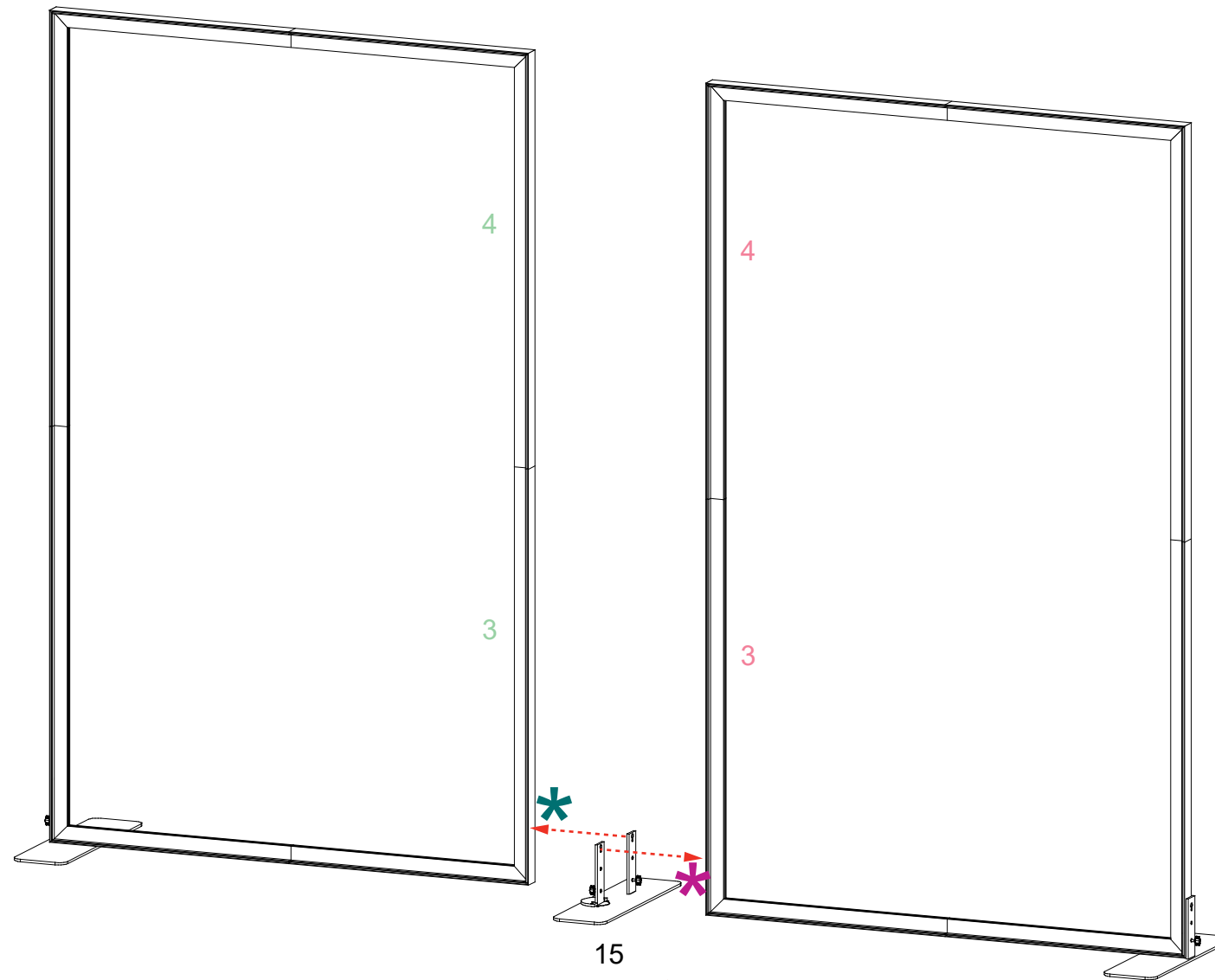
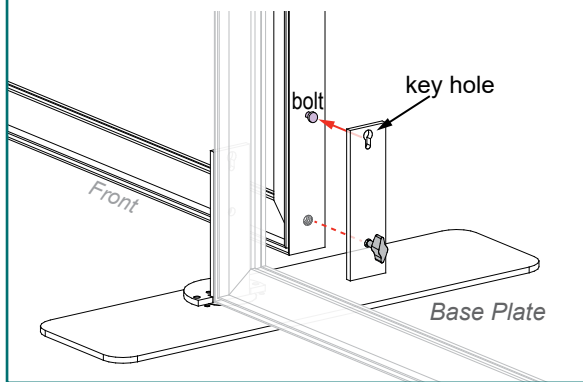

TOP VIEW

FRONT VIEW

SEG Graphic Installation

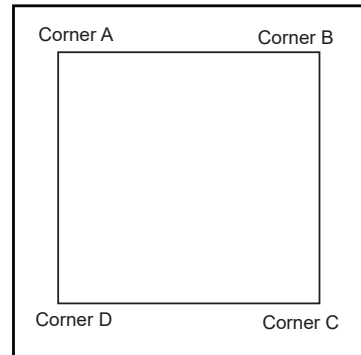

It is important to first insert graphic into each alternate corner, then to the sides of the frame. If this is not done, graphic will not fit into the frame correctly.

Step 1
Insert corner A. Turn edge of graphic so silicon welt is perpendicular to face of graphic. Insert narrow side of welt with fabric to outside into the channel. Repeat for other side of this corner.



Step 2
Repeat Step 1 for opposite corner C, then insert corner B, followed by corner D, to complete the installation of the corners.



Step 3
Once all corners are inserted, press one silicon edge into channel from corners and work toward the center. Make sure welt is fully inserted into channel. Continue until all sides are done. Smooth out edges of graphic.

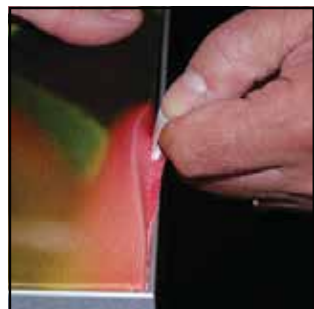

Graphic Removal

To remove the graphic from the frame, locate the fabric pull tab. Gently pull up on the tab to remove the fabric.

Steps:
1) Apply SEG Graphic to front of assembled frame.

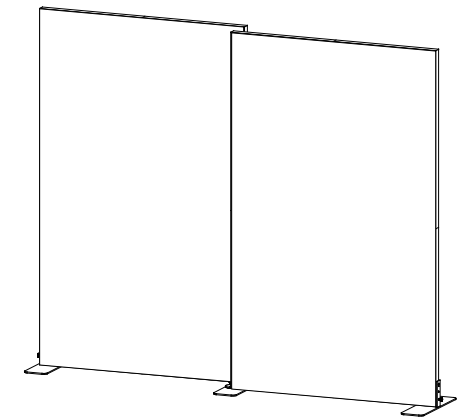

When assembled

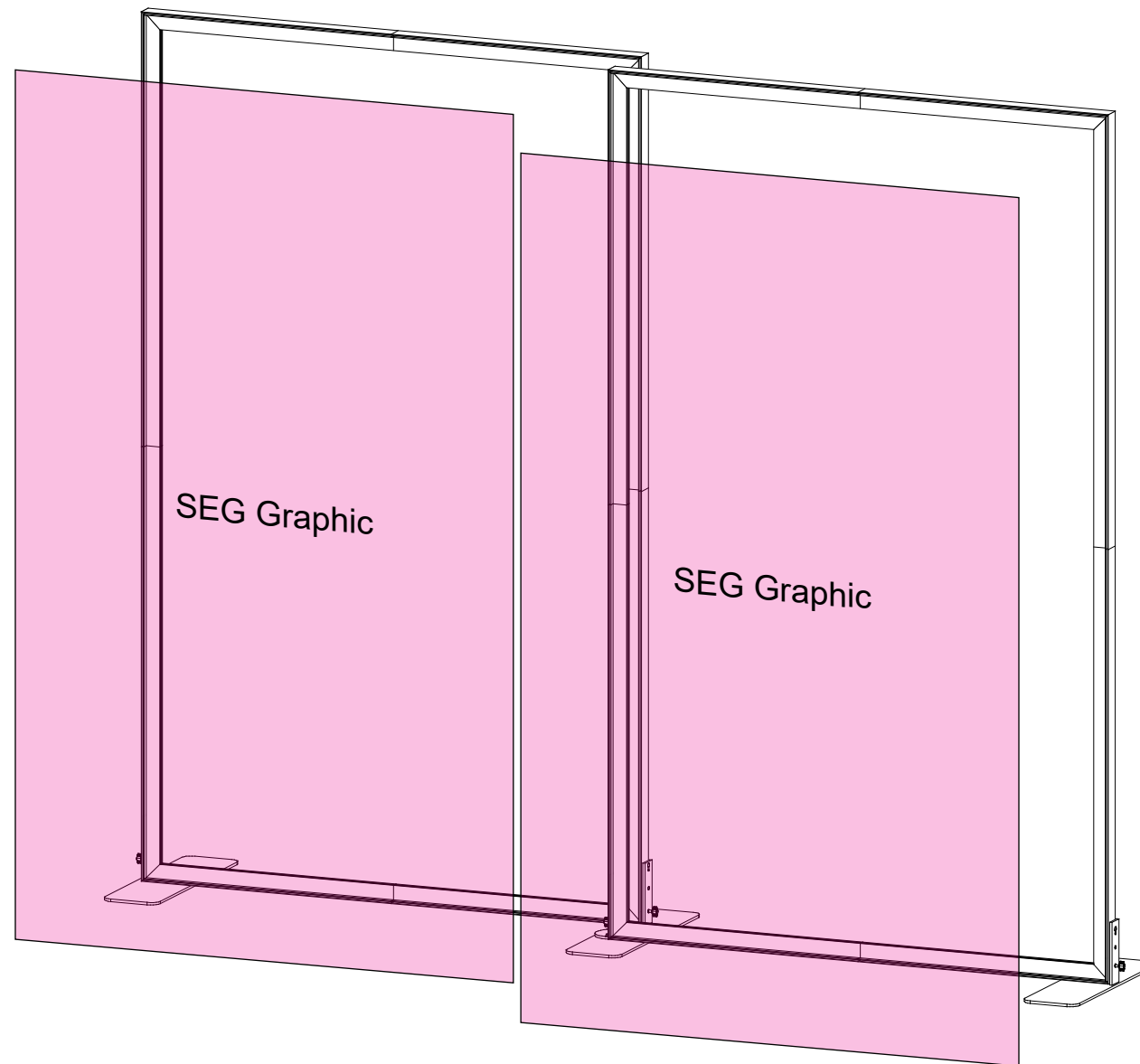

FRONT VIEW

*** Workstation Bracket Attachment**

① Hook the Mounting Bracket over the vertical extrusion.

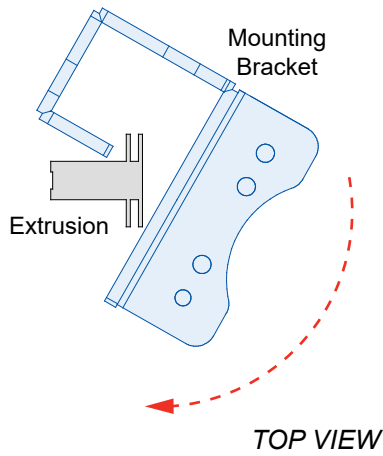

TOP VIEW

② Slide bracket forward, then down onto V4 connector.

V4 connectors stay permanently attached to vertical extrusion.

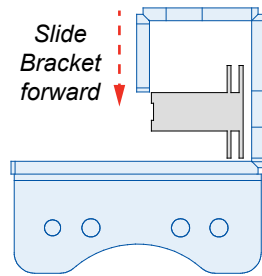

③ Tighten thumb screws to secure connection to inside of frame.

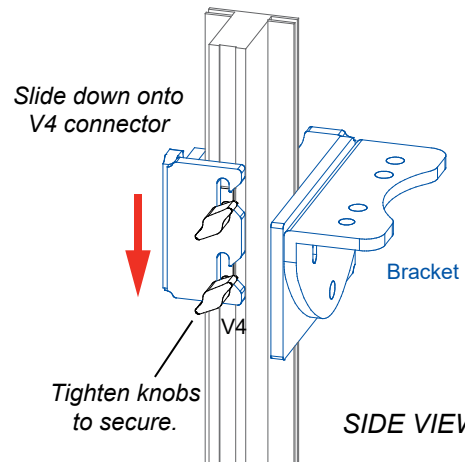

SIDE VIEW

Workstation Assembly

1) Attach threaded studs on underside of Counter Top to Counter Legs; secure with wing nuts.

2) Connect Counter Top to Mounting Bracket, using wing nuts.

3) Attach power cords to wireless chargers.

Keep cords attached to underside of counter top.

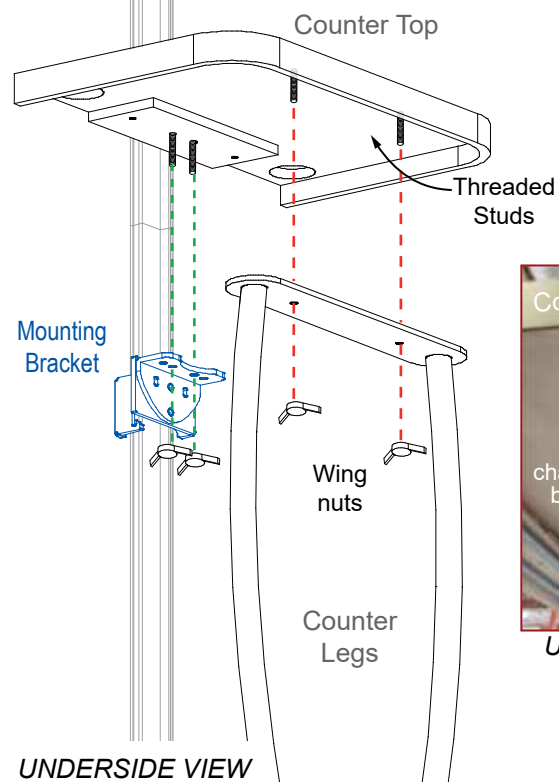

UNDERSIDE VIEW

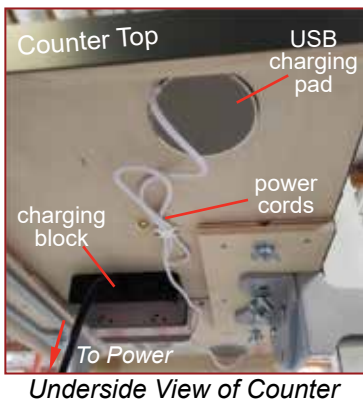

*** Light Attachment**

Attach clamp of stem light to top of horizontal extrusion where desired.

Twist knob on back to tighten in place.

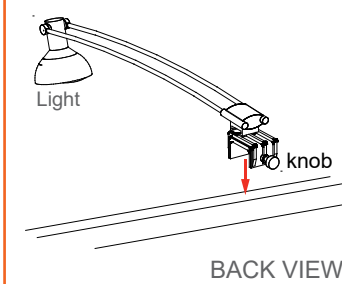

BACK VIEW

Steps:

- 1) Attach Workstation Mounting Bracket to backwall vertical as shown. See [Workstation Bracket Attachment](#) detail.
- 2) Assemble Workstation legs & counter top to bracket. See [Workstation Assembly](#) detail.
- 3) Attach Lights to top of backwall as shown. See [Light Attachment](#) detail.

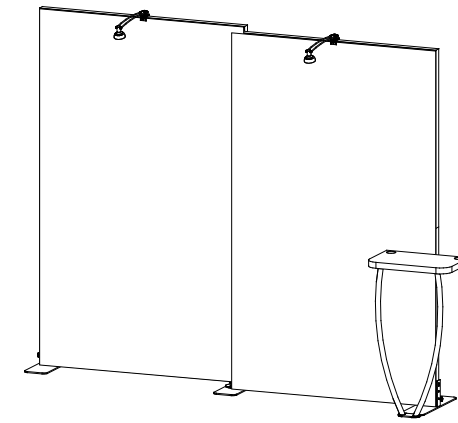

Completed Assembly

